

Product Specifications

Full Color Asynchronous Control Card

HD-D05

V2.0 20190827

1. System Overview

HD-D05 is a full color LED screen asynchronous control system that supports Wi-Fi connection, mobile APP control.

HD-D05 has 128MB memory space, which can be used to store program files for offline play.

It use HDPlayer and mobile APP-“LedArt” for management.

2. Communication mode

Upgraded programs by laptops, mobile phones with Wi-Fi connection or use U-disk for upgrade programs.

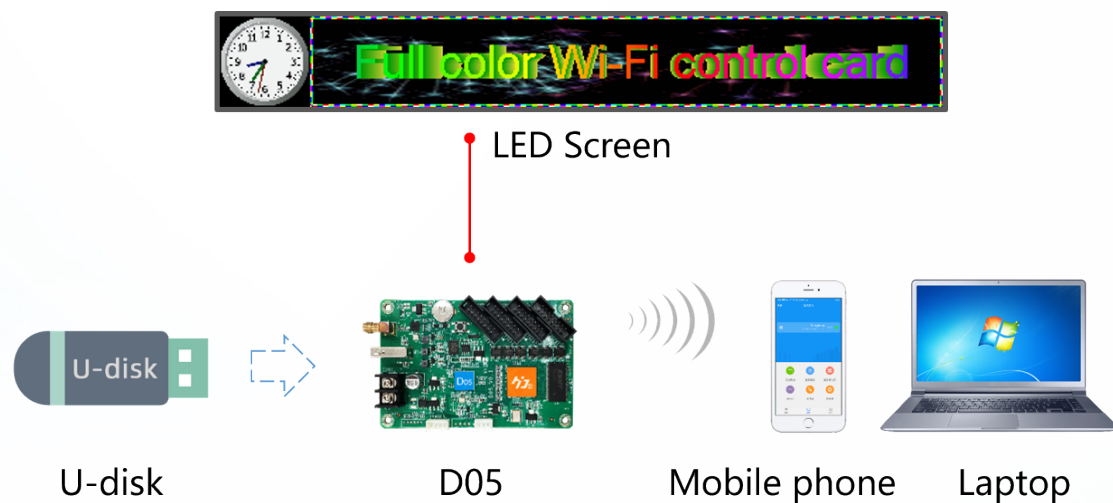

3. Product Features

1. Support variety full color modules,
2. Control range: 640*64,
3. Support 256~65536 gray level,
4. Support Image, Word art, Animation background, Neon light effect,
5. Support U-disk unlimited expansion program, plug in broadcast,
6. No need set IP address, HD-D05 could be identified by controller ID automatically,
7. Not support video play.

4. System Function List

Module type	Full color modules, Static to 1/64 scan mode
Control Range	640*64, Widest: 640, highest: 128
Gray Scale	256~65536
Animation Formats	SWF、GIF
Image Formats	BMP、JPG、JPEG、PNG etc.
Text	Support text message editing, inserting picture;
Time	analog clock, digital clock and a variety of dial clock functions
Other function	Neon, animations function; Clockwise/counter-clockwise count; support temperature and humidity; Adaptive brightness adjustment function
Memory	128MB, Indefinitely expanding memory by U-disk;
Communication	U-disk, Wi-Fi
Port	5V Power *1, 4 lines HUB75E
Software	HDPlayer, LedArt
Power	3W

5. Interface Definition

Support 4 groups HUB 75E parallel data are defined as follows:

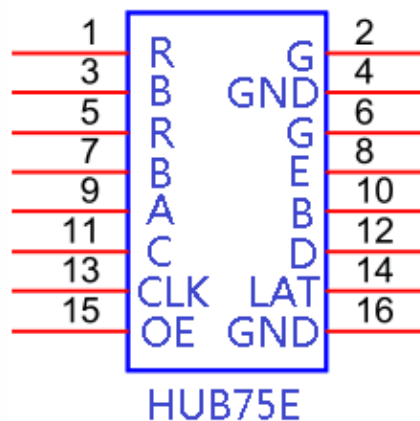

6. Dimension Chart

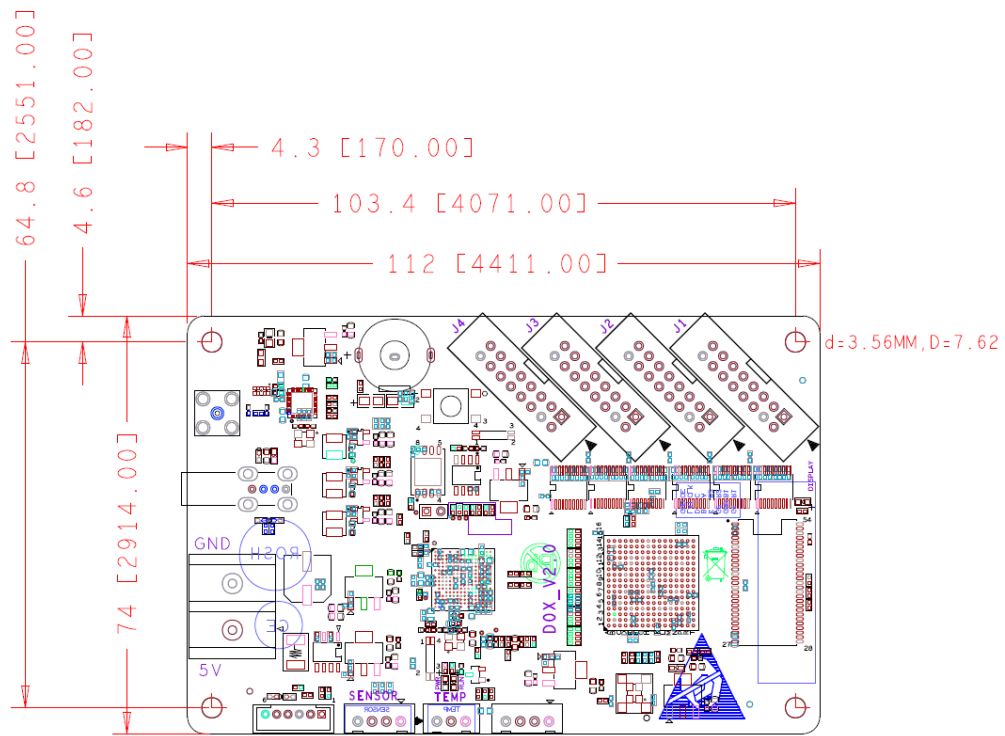

7. Interface Description

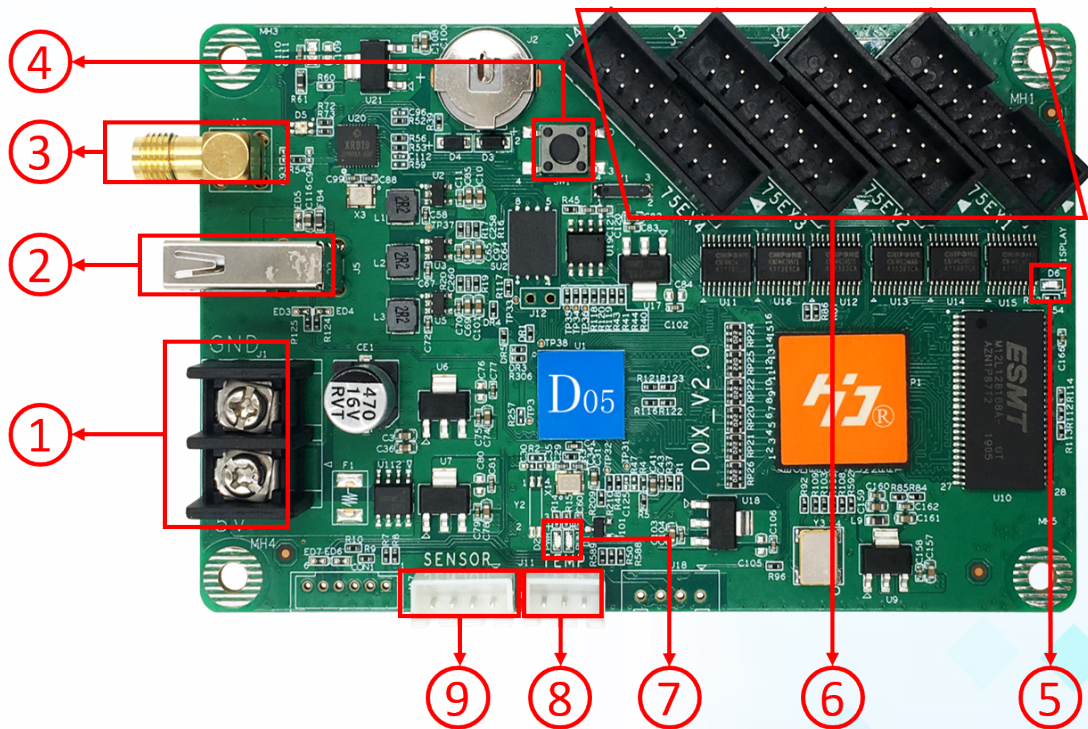

1. Power terminal, connect 5V power,
2. USB port, connected to USB device for update programs, e.g. U-disk, Mobile hard disk, etc,
3. External antenna interface: Connect the antenna to enhance Wi-Fi signal,
4. Test button: for test the brightness and contrast of the display screen,
5. Display light (Display), normal working state is flashing
6. HUB75E port: connect LED screen by cable,
7. Power light and running light: D1 is running light, D2 is power light, normal working state: power is always on, run flashes,
8. Temperature Sensor port: for connect to Temperature;
9. Sensor Port: for connect external sensor.

8. Basic Parameters

	Minimum	Typical	Maximum
Rated voltage(V)	4.2	5.0	5.5
Storage temperature(°C)	-40	25	105
Work environment temperature(°C)	-40	25	80
Work environment humidity (%)	0.0	30	95
Net weight (kg)	0.056		
Certificate	CE, FCC, RoHS		

Precaution

- 1) To ensure that the control card is stored during normal operation, make sure the battery on the control card is not loose;
- 2) In order to ensure the long-term stable operation of the system; please try to use the standard 5V power supply voltage.